

Water Point
Millenium



SWIMMING POOL EQUIPMENT AND ACCESSORIES MANUFACTURER

Designed by : Web Flow India

Call Us Now

+91-9837036023

+0562-4062700

waterpoint2002@gmail.com

www.waterpointindia.com



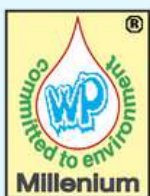

Water Point
Millenium

ABOUT US

Water Point was set-up in a prime location of the national capital Region to bring to India Swimming Pools, Swimming Pool Equipment and Accessories of Australian brand Millenium. World-class equipment and accessories are made available to buyers from all facets of hospitality industry as well as interior designers who residential and commercial projects. We are a dealer of Swimming Pool Aluminium Vacuum Head, Pipe Less Swimming Pool Filter, Swimming Pool First Aid Kit, PEB Swimming Pool, Swimming Pool Drain Cover, and much more. As an ISO 9001-2015 certified company, we take a stand for providing our customers with equipment and accessories that are easy to install and performance oriented.

OUR SERVICES FEATURES



POOL CONSTRUCTION SERVICES

We are ready to bring your pool into reality using the latest pool construction techniques and materials.



POOL WATERPROOFING SERVICES

Our Company Offers Swimming Pool Waterproofing Service To The Customers Who Are Willing To Build A Swimming Pool At Their Place.



POOL EXCAVATION SERVICES

Has your pool seen better days? We can update and upgrade equipment, renovate liners, decks and more.



POOL DESIGNING SERVICES

Our Company Is Leading In Rendering Swimming Pool Digging Service To The Customers.



POOL REPAIR SERVICES

Don't let a leak or mechanical issue keep you from enjoying your pool. Our service technicians are here to help!



POOL BUILDERS

We Are A Renowned Swimming Pool Builder, And Provide This Service For All Types Of Swimming Pools, Whether Commercial Or Residential.



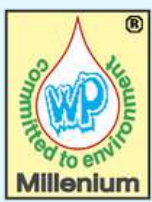

Water Point
Millennium

SERVICES

POOL TYPES

ROOFTOP/ INFINITY TYPE POOL



During each and every step of the project, our dedicated team members responsible for your project pay extra attention in implementing the design of swimming pool with a calculative measuring of the ground and proper levelling is done so that you are able to enjoy the swimming pool for years to come. Each of the pool constructed from our end is designed and constructed through following the standard code of principle and regulations that impart complete makeover to your property. We offer you with a top notch quality of structure at the most affordable rates.

OVERFLOW TYPE POOL

Overflow pool has at least one edge over or more through which water overflows & creating a dramatic visual effect. Overflow type pools are construct with over flow drain channel on the sides of the pool with top edge and water over flows to the drain this water travel to a balancing tank and then pool pump take the water from balancing tank and feed to the pool this complete the cycle of filtration process.



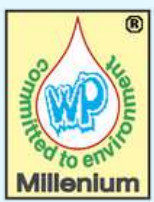

Water Point
Millennium

HYDRO THERAPY / COUNTER CURRENT TYPE POOL



These pools are purposely built indoor to maintain the temperature of water. Hydrotherapy is a therapeutic whole-body treatment that involves moving and exercising in warm water; essentially physiotherapy in a pool. Hydrotherapy pools are usually different from ordinary pools. Temperature & pressure of water is controlled and changed according to requirements. Suggestible temperature of pool should be 28 degree to 35 degree Celsius.

COMPETITION TYPE POOL

Competition Type Pool - With the exclusive, flexible Water Point Pools design/build system, our work easily meets the exacting needs of the world's top aquatic competition venues. Our competition pools and performance pools deliver gold-medal standards for swimming, water polo, artistic swimming, diving and high diving.



JACUZZI TYPE POOL



Jacuzzi is generally constructed from a permanent hard material and is designed to suit your specific tastes. These Jacuzzi spas are actually a type of custom spa that is set into the ground, with the top of the spa located at or near ground level.



Water Point
Millennium

SWIMMING POOL CONSTRUCTION SERVICES

SWIMMING POOL DESIGNING SERVICE

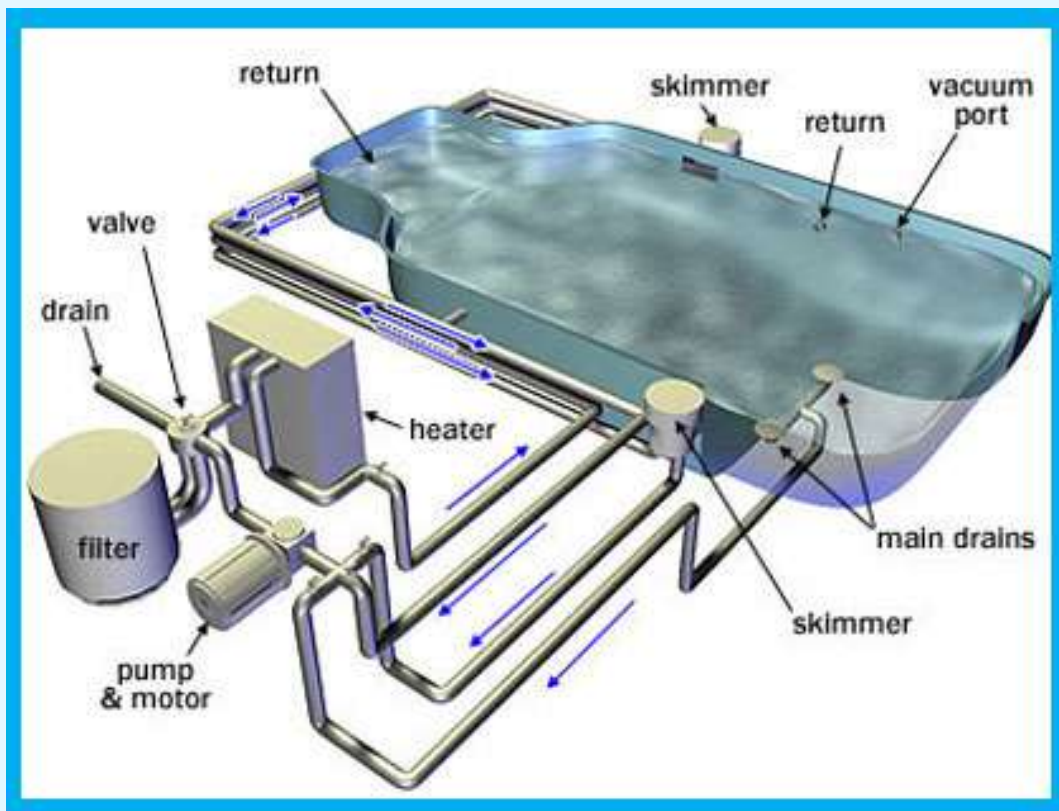

We are a renowned Swimming Pool Builder, and provide this service for all types of swimming pools, whether commercial or residential. Assured timely completion of work with high level of excellence is offered to the customers. Optimum quality material is used for the construction purpose which makes the pool look more impressive and attractive.

SWIMMING POOL EXCAVATION SERVICE

Our company offers construction service of Swimming Pool Concrete to the customers wishing to build a swimming pool at their place. The service is offered by our expert and skilled workers who ensure excellence in their work. The construction service is rendered within the stipulated time and as per the specifications.





Water Point
Millennium

SWIMMING POOL CONSTRUCTION SERVICE



Owing to the tremendous expertise in the functional domain, our company Halbert Swimming Pool engrossed in providing Swimming Pool Construction Service to the clients across the city of Delhi. Offered construction services are rendered under the supervision of our deft architects who construction swimming pool with creativity and utmost perfection. Our professionals swimming pool contractor utilizes high quality raw materials and other materials to construct the pool with the aid of innovative technology as per defined market norms. Moreover, these Swimming Pool Construction Service are rendered by us at marginal prices to our respectable clients.

SWIMMING POOL WATERPROOFING SERVICE

Our company offers Swimming Pool Excavation Service to the customers who are willing to build a swimming pool at their place. The service is highly reliable and is rendered by skilled workers who ensure perfection in their job. The Swimming Pool Excavation Service is provided for all kind of swimming pools such as roof top, hot tub and spa, competition, public and private pools. Also, we hold expertise to excavate all types of large and small pools. The task is completed within the stipulated time frame and as per the required specifications by ensuring high level of excellence in the service.

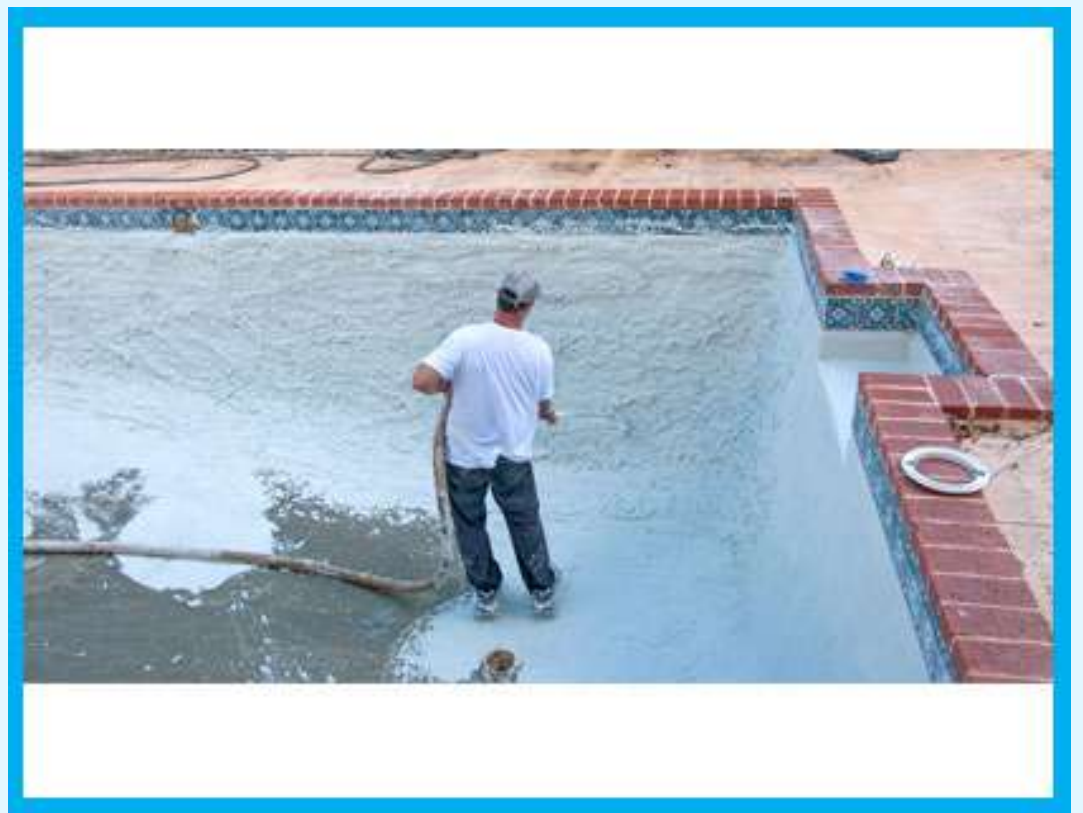



Water Point
Millennium

SWIMMING POOL TILES INSTALLATION



We are a prominent Swimming Pool Water proofing and take complete responsibility to Water proof your swimming pool as per the required specifications . Clients are assured timely and efficient completion of the Water proof. Also, being a leading Swimming Pool Water proof, we provide Water proof service for all kinds of pools whether small or large, commercial or residential. Using latest Water proofing methods and using optimum quality material, the service is rendered by skilled workers who ensure perfection in their work.

SWIMMING POOL REPAIR SERVICE

Our company is leading in rendering Swimming Pool Digging Service to the customers. The service is ideal for all types of swimming pools, small or large, commercial or residential. The digging service is rendered by hardworking workers under the supervision of experts by using latest machines such as cranes to ensure perfection in work. Our Swimming Pool Digging Service is offered as per the required specifications. Also, we assure timely completion of the work with with no compromise on the excellence.





Water Point
Millennium

FOUNTAIN CONSTRUCTION SERVICES

OUTDOOR FOUNTAINS



GEYSER JET FOUNTAINS

We have manufacturer Exclusive range of Geysers Jet Fountains to decorate your Hotel, Resorts & Banquets, Bungalow and Garden etc.



BELL JET FOUNTAINS

We have manufacturer Exclusive range of Bell Jet Fountains to decorate your Hotel, Resorts & Banquets, Bungalow and Garden etc.



DANDELION FOUNTAINS

We have manufacturer Exclusive range of Dandelion Fountains to decorate your Hotel, Resorts & Banquets, Bungalow and Garden etc.



FLOWER JET FOUNTAINS

We have manufacturer Exclusive range of Flower Jet Fountains to decorate your Hotel, Resorts & Banquets, Bungalow and Garden etc.



Water Point
Millenium

MUSICAL FOUNTAINS



MUSICAL FOUNTAINS MO5

We are the leading manufacturer and exporter of a wide range of Musical Fountain to our respected clients. These are appreciated for its



MUSICAL FOUNTAINS MO8

We are the leading manufacturer and exporter of a wide range of Musical Fountain to our respected clients. These are appreciated for its



MUSICAL FOUNTAINS MO9

We are the leading manufacturer and exporter of a wide range of Musical Fountain to our respected clients. These are appreciated for its



MUSICAL FOUNTAINS MO11

We are the leading manufacturer and exporter of a wide range of Musical Fountain to our respected clients. These are appreciated for its

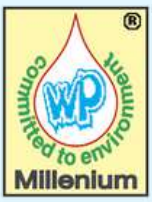

PROGRAMMABLE FOUNTAINS



PROGRAMMABLE FOUNTAINS PR1

We are the leading manufacturer and exporter of a wide range of Programmable Fountains PR1 to our respected clients. These are appreciated for its



PROGRAMMABLE FOUNTAINS PR4

We are the leading manufacturer and exporter of a wide range of Programmable Fountains PR4 to our respected clients. These are appreciated for its



PROGRAMMABLE FOUNTAINS PR9

We We are the leading manufacturer and exporter of a wide range of Programmable Fountains PR9 to our respected clients. These are appreciated for its



PROGRAMMABLE FOUNTAINS PR10

We are the leading manufacturer and exporter of a wide range of Programmable Fountains PR10 to our respected clients. These are appreciated for its



Water Point
Millennium

FLOATING FOUNTAINS



FLOATING FOUNTAINS

We are the leading manufacturer and exporter of a wide range of Floating Fountains to our respected clients. These are appreciated for its



FLOATING FOUNTAINS

We are the leading manufacturer and exporter of a wide range of Floating Fountains to our respected clients. These are appreciated for its



FLOATING FOUNTAINS

We are the leading manufacturer and exporter of a wide range of Floating Fountains to our respected clients. These are appreciated for its



FLOATING FOUNTAINS

We are the leading manufacturer and exporter of a wide range of Floating Fountains to our respected clients. These are appreciated for its



Water Point
Millennium

WATER CURTAIN

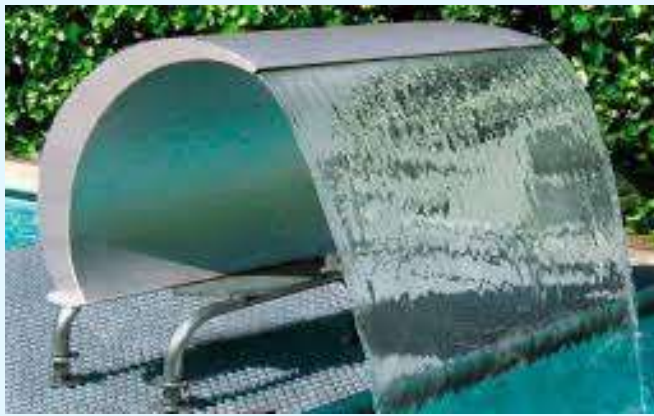



Water Point
Millenium

POOL FILTERS

POOL TOP MOUNT SAND FILTER



FEATURES:

The fiberglass winding design enables the filter to be durable, deforming-proof and corrosion resistant. A unique and advanced design ensures fast draining and stabilizes water flow.

The 6-position multi-port valve with a user friendly handle easily provides you a maximum flow at low pressure drop.

The Sand filter comes with a precise pressure gauge. It is easy to install and to maintain.

The Outlet turbidity is less than 2FTU.

Working pressure is 2.5 Kg cm²/36 psi.

UV resistance surface allows the filter to work under direct sunlight.

Maximum operating temperature is 50°C.

POOL SIDE MOUNT SAND FILTER



The fiberglass winding design enables the filter to be durable, deforming-proof and corrosion resistant. A unique and advanced design ensures fast draining and stabilizes water flow.

The 6-position multi-port valve with a user friendly handle easily provides you a maximum flow at low pressure drop.

The Sand filter comes with a precise pressure gauge. It is easy to install and to maintain.

The Outlet turbidity is less than 2FTU.

Working pressure is 2.5 Kg cm²/36 psi.

UV resistance surface allows the filter to work under direct sunlight.

Maximum operating temperature is 50°C.

Smooth & High brightness appearance easy to clean.



Water Point
Millennium

HIGH QUALITY FILTER MEDIA



The single media filtration by use of filter sand is widely spread as a general filtering method. However in these days the treated water quality standards are tightened in addition to the deterioration problem of raw water quality arisen from the growth of algae and cryptosporidium, the part of filtration, which is a key point of water purification become more important and performance is required. Pre-filtration to protect membrane process from fouling. Filtration of cooling water to prevent heat exchanger fouling. Pressure filters uses granular media to remove contaminants from water.

POOL CARTRIDGE FILTERS



FEATURES:

Single locking knob securely fastens head to filter tank, eliminating bolts.

Attractive, durable filter head can be rotated to conveniently position pressure gauge and manual air relief.

Injection-moulded filter tank for dependable, corrosion-free performance.

Elevated, filtered water collector and debris sump prevents accidental by-pass of heavy debris to pool or spa when cartridge is removed for cleaning.

Working pressure is 2.5 kgf/cm square/36 psi.

Outer cover made of reinforced plastic & cartridge element is made of working polyester material.

Suitable for inground pools, Public Pools, Water Amusements Parks, Sea Water and Fresh water breed aquatics.

Cartridge element can be reused after cleaning.



SUPERIOR POOL PIPELESS FILTER



Pipeless Filter

The enclosure of wall-mounted filter is made of high quality Acrylic, so the filter installation without room, simple installation, convenient operation, excellent performance thereby reducing the construction cost. The filter is made according to Countries codes and standards.

TECHNICAL CHARACTERISTICS

Dimensions	1110 X 67 X 780mm
Flow Rate	10m ³ /h 15m ³ /h
Voltage	220v / 50hz or 60hz
Precision Of Filtration Bag	5u
Operating noise	50Db
Material	Acrylic
Installation	Wall Mounting

EQUIPMENT

Filtration Pump	1X1HP	1X1 5HP
Filtration basket with bag	1pc	
Chlorine feeder	1pc	
Light (Warm White)	1XLED	12W/12V
Time Controller	1pc	
Swim jet	2pcs	
Handle Rail(S.S)	2pcs	
Ozone (optional)	1pc	(options)

SYSTEM

Filtration System	1pc
Disinfection System	1pc
Time Control System	1pc
circle System	1pc
Lighting System	1pc

MULTIPOINT VALVE



Top Mount Multiport Valve

FEATURES:

- Able to Operate under Prolong sun light.
- Six way features available.
- Easy to install.
- Easy to Maintain.
- Smooth and high brightness.
- Pressure gauge from 0-30 PSI to 0-60 PSI.
- Handle for easy Operation.



Water Point
Millennium

COMBO FILTER PUMP



Combo Filter Pump

Designed For easy set up domestic pool,PSF series filtration combo offers the right solution for home user who is looking for user friendly and excellent filtration performance. FSF Series filtration Combo include top mount fiberglass filter tank-6 way muliport valve swimming pool pumps attatched with base.

HIGHLIGHT FEATURES:

Max Operating Pressue 36psl/2.5 bar

Max temperature of 43°C (109 f)

Universal Standard of union connection provided
suggested size of media:0.5-1.2mm

CARTRIDGE ELEMENT



Cartridge Element

VERTICAL DEEP BED SAND FILTER



Vertical Deep Bed Sand Filter



POOL PUMPS

SWIMMING POOL PUMP



WP 075 And WP 100

Pole induction motor Single-phase : 220-240/50Hz Single-phase with thermal protector

- Capacitor inset
- Insulation class F
- Protection IPX5
- Continuous duty

FEATURES

Wet ends made of high reinforced engineering thermal plastic with compact structure and corrosive-resistance.
1.5 inch Inlet and Outlet
High efficient structure design for diffusor and impeller to get higher performance
No contact between motor shaft and liquid.
. Motor / Pump shaft has no contact with the water
Continuous Operations

COMMERCIAL SERIES PUMP



Commercial Series Pump

MATERIALS

- Self priming pump
- Injected thermo plastic pump casing
- Filter basket in white color injected plastic material
- Prefilter lid in transparent polycarbonate
- Stainless steel studs
- Impeller and seal mounting in PPO
- Motor shaft in stainless steel AISI 420
- Mechanical seal in graphite and SIC
- Motor housing in aluminium L2521

MOTORS

1. Asynchronous, two poles
2. IP 55 protection
3. Class F insulation
4. Continuous operation
5. Single phase version built in thermal protection



SWIMMING POOL PUMPS



Swimming Pool Pump

MOTOR

1. Asynchronous, two poles
2. IP 55 protection
3. class F Insulation
4. Continuous operation
5. Single phase version built in thermal protection

MATERIALS

- Self priming pump
- Injected thermo plastic pump casing
- filter basket in white color injected plastic material
- prefilter lid in transparent polycarbonate
- Stainless steel studs
- Impeller shaft i stainless AISI 420
- Mechanical seal in graphite and SIC
- Motor housing in aluminum L 2521

COUNTER FLOW PUMP



Counter Flow Pump

Output:- 4KW / 5.5HP 220 / 380V / 50HZ
Q.MAX:- 1167 l/min
H.MAX:- 14.5m
R.P.M:- 2850 r/min IP55
Size:- 75mm X 75mm

Modal: HWCC04003-02

Singal Stage Certifugal Pumps With Complete Drainage Device.

Inbuilt counterflow System:

This jet Stream is for easy installation. It is possible to regulate The jet Strength and air suction. On the Nozzle of 40mm In diameter, Which is directionally adjustable. The Nozzle, Suction And Phneumatic Switch are Positional In The Front Cover Panel of The equipment. Complete Flow System Include:-

Counter Flow Nozzle 40mm Front Cover Pannelk Attractive Design Pool wall lead through pump Electro pneumatic Switch safety Element PVC Fitting

MOTOR:

Asynchronous, Two Poles, IP 55 Protection
Class F Insultion

MATERIAL:

Suction and Discharge Mountings In Polyproplier
Motor Shaft Stainless Steel 304



Water Point
Millennium

HQ 150, HQ 200, HQ 300



APPLICATIONS:

Jet pump for bath tubs, spa pools, swimming pools, massage stations and cleaning systems.

FEATURES:

- Motor / Pump shaft has no contact with the water.
- Total electrical separation.
- 2.2L pre filter.
- 2" Inlet & outlet.

OPERATIVE CONDITIONS:

- Liquid temperature from +5°C ~ +60°C
- Ambient temperature up to 50°C
- Max. working pressure : 3 bar

MOTOR:

- 2-pole induction motor single-phase : 220-240/50HZ single-phase with thermal protector T.I.
- Capacitor Inset
- Insulation class F
- Protection IPX5

SPA PUMP



Hi Pressure SPA PUMP available with its different variant

- Stainless Steel Studs.
- Injected Thermo Plastic Pump Casing.
- Suction and Discharge in polypropylene.
- Impeller in PPO.
- Mechanical Seal in SIC & SIC.
- IP 55 Insulation.
- Motor Housing in aluminium L 2521.
- Continuous Operation.
- Application for Spa, Jacuzzi, and Bath Tub.

WORKING CONDITIONS:

Medium temperature: 5-50°C

Environmental temperature : < 40°C

Max. working pressure: 0.3 MPa

PRODUCT FOCUS:

Best working point, large flow, high efficiency. Electric pump over-current components using high-strength engineering plastic, with high-quality wear-resistant mechanical seal; Three phase motor apply for gasket and tread to avoid impeller reversal and loose; The stator is applied by molding process with resistance. Moisture. heat security, 90 frame equipped with specialized plastic mounting bracket pump apply for low noise standard motor. Single-phase with thermal protector from TI, USA; Motor is with high temperature bearings, long operating life with reliability and durability; Complete separation of water and the axis, safe and reliable; Insulation class F, Protection IPX5. The pump obtained the certification of CE.

Designed by : Web Flow India



Water Point
Millennium

POOL LIGHTS

POOL LED LIGHT 10/12/18/20 WT



Model No: MA-061

Led Under Water Light (SS)
Diameter-150mm
Material-SS 304
IP-68, ABS Blue Ring Top, Surface Mount
High Quality Electrical Cable 1m
Volts/Walts: 12V/10W/20W
Led Color:Warm/Cool White/RGB/Blue

POOL LED LIGHT 10/12/18/20 WT



Model No:MA-061

Led Under Water Light (SS)
Diameter-150mm
Material-SS 304
IP-68, ABS Blue Ring Top, Surface Mount
High Quality Electrical Cable 1m
Volts/Walts: 12V/10W/20W
Led Color:Warm/Cool White/RGB/Blue



Water Point
Millenium

LED UNDER WATER LIGHT (SS)



Model No:MA-062

Led Under Water Light (SS)
Diameter-150mm
Led Type SMD
Material SS 304
IP-68
Volts/Walts: 12V/10W/20W
Led Color: Wall Mount Light (Concrete Pool

FOUNTAIN UNDER WATER LIGHT



MODEL NO:MA-064

Fountain Under Water Light
Diameter-150mm,175mm Material-SS 304 IP-68
Volts/Walts: 12V/18W/27W
Led Color: Warm/Cool White/RGB



Water Point
Millennium

LED UNDER WATER LIGHT



MODEL NO:MA-065

Led Under Water Light
Diameter-100mm
Material-SS 304
IP-68, Surface Mount
Volts/Walts: 12V/10W/12Wt/18Wt/20Wt
Led Color: Warm/Cool White/RGB/Blue

POOL LED LIGHT 100 WT



MODEL NO: MA-066

LED Under Water Light
Diameter-190mm
Thickness-32mm, Material-ABS
IP-68, 100% Water Proof
Electrical Cable 1 mtr
Volts/Watts: 12V/12,14,18,20W

POOL LED LIGHT 9/ WT



MODEL NO:MA-067

Led Under Water Light
Diameter-100mm
Material-ABS IP-68, Surface Mount
Volts/Walts: 12V/9W/10W
Led Color: Warm/Cool/RGB/Blue



Water Point
Millennium

POOL LED LIGHT 10/12/18/20 WT



MODEL NO:MA-068

Led Under Water Light
Diameter-167mm
Thickness-22.5mm
Material ABS, Led Type-SMD
High Quality Electrical Cable 1m
Volts/Walts: 12V/10W/12W/20W/24W
Led Color: Warm, Cool, White and RGB

POOL LED LIGHT 9/10 WT



MODEL NO:MA-069

Fountain Led Under Water Light
Diameter-100mm, Material-ABS
Stand Type, Height With Stand-142mm
Thickness-23mm, Niche Dia-80mm IP-68
Volts/Walts: 12V / 9W DC
Led Color: Warm/Cool White/RGB

FOUNTAIN LED UNDER WATER LIGHT



MODEL NO:MA-071

Fountain LED Under Water Light
Round Dia-160mm
Angle 30-45 deg.
Material SS 304, IP-68
with stand
Volts/Walts: 12V/27W
Light:Warm/Cool White/ Multi Color



Water Point
Millennium

FOUNTAIN LED LIGHT



MODEL NO:MA-075

Fountain Led Light
Material SS 304
Angle 30 deg
Round dia-75mm, IP-68
Volts/Walts: 12V/9W
Light:Warm/Cool White/ Multi Color

FOUNTAIN UNDER WATER LIGHT (STAND)



MODEL NO:MA-080

Fountain Under Water Light (Stand)
Diameter-110mm
Material-SS 304
IP-68
Volts/Walts: 12V/9W/18W
Light:Warm/Cool White/ Multi Color

FOUNTAIN LED LIGHT 24/27/36 WT



MODEL NO:MA-071

Fountain LED Under Water Light
Round Dia 160mm
Angle 30-45 deg.
Material SS 304, IP-68
Volts/Walts: 12V/36W
Light:Warm/Cool White/ Multi Color

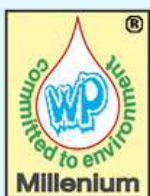

Water Point
Millenium

FOUNTAIN LED LIGHT 12/18 WT



MODEL NO:MA-078

Fountain Led Light (Nozzle Mount)
Round dia 100mm
Material SS 304
Angle 30
IP-68
Volts/Walts: 12V/18Wt
Light:Warm/Cool White/ Multi Color

LED UNDER WATER LIGHT



MODEL NO:MA-066

LED Under Water Light
Diameter-190mm
Thickness-32mm, Material-ABS
IP-68, 100% Water Proof
Electrical Cable 1 mtr
Volts/Watts: 12V/12,14,18,20W

LED UNDER WATER LIGHT (SS)



MODEL NO:MA-062

Led Under Water Light (SS)
Diameter-150mm
Led Type SMD
Material SS 304
IP-68
Volts/Walts: 12V/10W/20W
Led Color: Wall Mount Light (Concrete Pool)



Water Point
Millennium

FOUNTAIN LED LIGHT 12/18 WT

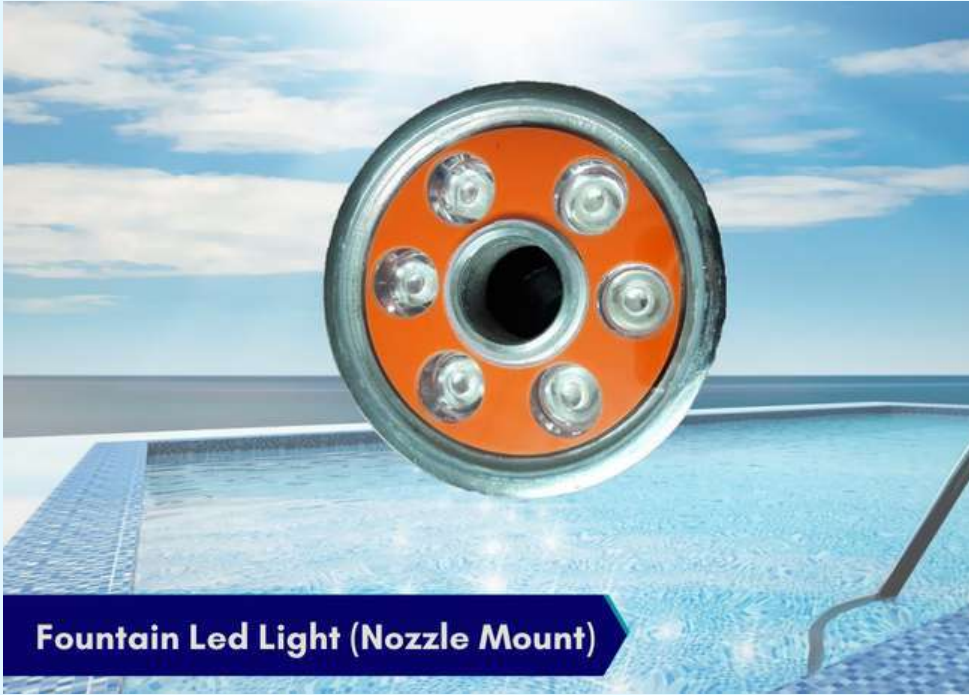

MODEL NO:MA-078

Fountain Led Light (Nozzle Mount)
Round dia 100mm
Material SS 304
Angle 30
IP-68
Volts/Walts: 12V/18Wt
Light:Warm/Cool White/ Multi Color

LED UNDER WATER LIGHT (SS)



MODEL NO:MA-062

Led Under Water Light (SS)
Diameter-150mm
Led Type SMD
Material SS 304
IP-68
Volts/Walts: 12V/10W/20W
Led Color: Wall Mount Light (Concrete Pool)

UNDER WATER LIGHT



MODEL NO:MA-066

under water light
Diameter-190mm Thickness-32mm, Material-
ABS IP-68, 100% Water Proof Electrical Cable
1 mtr
Volts/Watts: 12V/12,14,18,20W

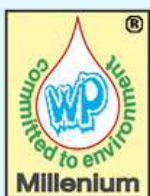

Water Point
Millennium

SOLAR FLOATING POOL LIGHT (COLORFUL)



MODEL NO:MA-070

Solar Floating Pool Light (colorful)

Type - Floating without wire

Volts/Walts:

Led Color: Warm, Cool, Blue and RGB

FOUNTAIN UNDER WATER LIGHT



MODEL NO:MA-072

Fountain Under Water Light

100% Waterproof Round Dia 140/150mm Angle

30-45 deg, IP-68

Volts/Walts: 12V/36W

Light:Warm/Cool White/ Multi Color

FOUNTAIN LED LIGHT (NOZZLE MOUNT)



MODEL NO: MA-077

Fountain Led Light (Nozzle Mount)

Round Dia 150mm Angle 30-45 Material SS 304

IP-68

Volts/Walts: 12V/27W

Light:Warm/Cool White/ Multi Color



Water Point
Millennium

LED DRIVER FOR RGB UNDER WATER LIGHTS



Led Driver For Under Water Lights

MODEL NO:MA-083

Led Driver for RGB Under Water Lights
Led Controller for RGB Multicolor Light
Input Voltage-AC 220V Output Voltage-DC
12V
Body-MS Powder Coated

LED CONTROLLER



LED Controller

MODEL NO:MA-084

LED Controller
Power Supply available in 2A, 5A, 10A, 12.5A, 15A,
20A
Volts: 12V-DC

POOL LED LIGHT 10/12/18/20/24 WT



Led Under Water Light (ABS)

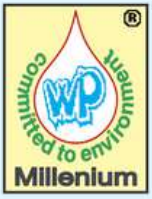

Water Point
Millenium



Led Under Water Light



Fountain Led Light



Mini Led Light



POOL CLEANING

STANDARD CURVED POLY BRISTLE WALL BRUSH - 18"



MODEL NO: MA-015

DESCRIPTION

Standard Curved Poly Bristle Wall Brush - 18"

Standard Packing	1
Weight (KG)	200gm
Size	18"

ALGAE CLEANING BRUSH



MODEL NO: MA-016

DESCRIPTION

Algae Cleaning Brush

Standard Packing	1
Weight (KG)	125gm
Size	18

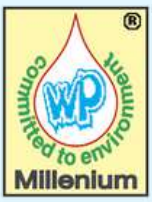

Water Point
Millennium

CURVED ALGAE BRUSH



MODEL NO:MA-018

DESCRIPTION

Curved Algae Brush

Standard Packing	1
Weight (KG)	190gm
Size	18"

STAINLESS STEEL ALGAE BRUSH WITH ALUMINIUM BACK 18"



MODEL NO: MA-020

DESCRIPTION

Stainless Steel Algae Brush with Aluminium back 18"

Standard Packing	1
Weight (KG)	367gm
Size	18"

DELUXE LINER VAC HEAD WEIGH



MODEL NO:MA-023

DESCRIPTION

Deluxe Liner Vac Head

Standard Packing	1
Weight (KG)	710gm
Size	14"

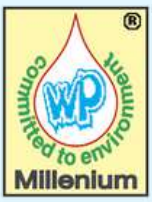

DELUXE LARGE VAC HEAD CAST IRON WEIGHT



MODEL NO:MA-024

DESCRIPTION

Deluxe Large VAC head cast iron weight

Standard Packing	1
Weight (KG)	710gm
Size	14"

DELUXE LARGE VAC HEAD CAST IRON WEIGHT WITH SIDE BRUSH



MODEL NO:MA-025

DESCRIPTION

Deluxe Large VAC head cast iron weight with side brush

Standard Packing	1
Weight (KG)	720gm
Size	14"

FLEXIBLE VACCUM HEAD FOR GROUND



MODEL NO: MA-029

DESCRIPTION

Flexible Vaccum Head For Ground

Standard Packing	1
Weight (KG)	-
Size	18"

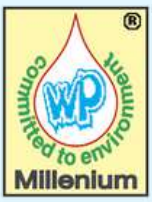

Water Point
Millenium

VACCUM BRUSH WITH SWIVEL



MODEL NO: MA-031

DESCRIPTION

Vaccum brush with swivel

Standard Packing	1
Weight (KG)	-
Size	18"

DELUXE TRIANGULAR VACUUM HEAD



MODEL NO:MA-032

DESCRIPTION

Deluxe Triangular Vacuum Head

Standard Packing	1
Weight (KG)	-
Size	14"

TRIANGULAR TRANSPARENT VACUUM HEAD



MODEL NO:MA-033

DESCRIPTION

Triangular transparent VAC head

Standard Packing	1
Weight (KG)	1.3kgs
Size	14"

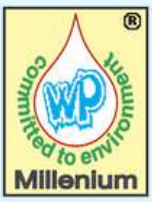

Water Point
Millennium

FLEXIBLE VACCUM HEAD W/8 WHEEL



MODEL NO:MA-035

DESCRIPTION

Flexible Vaccum Head W/8 Wheel

Standard Packing	1
Weight (KG)	1.1kgs
Size	14"

VACCUM HEAD W/AIR RELIEF VALVE



MODEL NO:MA-036

DESCRIPTION

Vaccum Head W/Air Relief Valve

Standard Packing	1
Weight (KG)	-
Size	14"

SS SUCTION HAED



MODEL NO:MA-035

DESCRIPTION

Suction Head

Standard Packing	1
Material	Stainless Steel
Size	2feet / 3feet



Water Point
Millennium

HEAVY DUTY PLASTIC LEAF SKIMMER WITH WEARING MESH



MODEL NO:HA-039

DESCRIPTION

Heavy Duty Plastic Leaf Skimmer With Wearing Mesh

Standard Packing	1
Weight (KG)	-
Frame	Aluminium

HEAVY DUTY DEEP RAKE



MODEL NO:MA-047

DESCRIPTION

Heavy Duty Deep Rake

Standard Packing	1
Weight (KG)	-
Color	Golden Handle

HEAVY DUTY LEAF SKIMMER



MODEL NO:HA-049

DESCRIPTION

Heavy Duty Leaf Skimmer

Standard Packing	1
Weight (KG)	-
Type	Flate



Water Point
Millennium

HIGH QUALITY HOSE PIPE



MODEL NO:HA-051

DESCRIPTION

High Quality Hose Pipe

Standard Packing	1
Weight (KG)	3.200 kg
Quality	EVA

TELESCOPIC CLEANING POLE



MODEL NO: HA-054

DESCRIPTION

2.4m Ribbed Pole/Telescopic Pole-1.1mm Thickness/Blue/Silver

Standard Packing	1
Weight (KG)	
Size(m)	(2 X 1.2)

SUPERME ROBOTIC POOL CLEANER



Automatic Swimming Pool Accessories Cleaning Robot Vacuum Cleaner Cleaning:

Cleans, vacuums and stores wastes and dirts thanks to its great filter bag Cleaning:

Cleans, vacuums and stores wastes and dirts thanks to its great fillter bag

Easy to clean

Optimized cleaning time for floor / wall / water line

REMOTE CONTROL:

Can be started or stopped remotely

Anti-jamming side domes:

Side domes allow the cleaning of hard to reach corners

Prevent the robot from getting stuck in certain angles and any contact

between the body and the liner

Designed by : Web Flow India

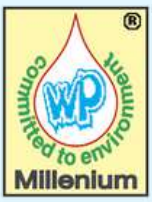

Water Point
Millennium

DELUXE LARGE VAC HEAD CAST IRON



MODEL NO:MA-047

DESCRIPTION

Deluxe large vac head cast iron

Standard Packing	1
Weight (KG)	710gm
Size	14"

FLEXIBLE VACCUM HEAD



MODEL NO:HA-032

DESCRIPTION

Flexible vaccum head with side brush for in ground pool

Standard Packing	1
Weight (KG)	1.1kgs
Size	14

SUCTION SWEEPER MACHINE COMPLETE UNIT



We offer our clients with a qualitative range of Swimming Pool Suction Sweeper Set. Being in accordance with the required industry standards, these machines are widely used in various swimming pools. These are also stringently checked on various parameters to ensure its durability and longer functional life. Moreover, these are acclaimed by our clients for features such as:

1. Motor Pump 1HP|1.5HP|2HP|3HP
2. Electrical Wire 20 Mtr.
3. On/Off Starter
4. SS Trolley
5. Easy for Operation
6. Prefilter Basket



Water Point Millenium



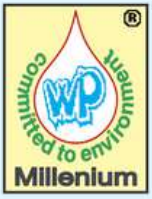

Water Point
Millennium

FOUNTAIN NOZZLES





Water Point Millennium





LADDERS

MLT SERIES LADDER

MLT Series Ladder Water Pool Ladders are made with high quality grade SS 304, stainless steel 38/42mm tube for reliability and durability complete with anchoring fixtures.



CODE	Trade s	A	B	C	D	E	F	G	H
MLT-215	2	510	700	250	1450	230	460	760	685
MLT-315	3	510	700	250	1700	230	460	760	685
MLT-415	3	510	700	250	1950	230	460	760	685
MLT-515	4	510	700	250	2200	230	460	760	685

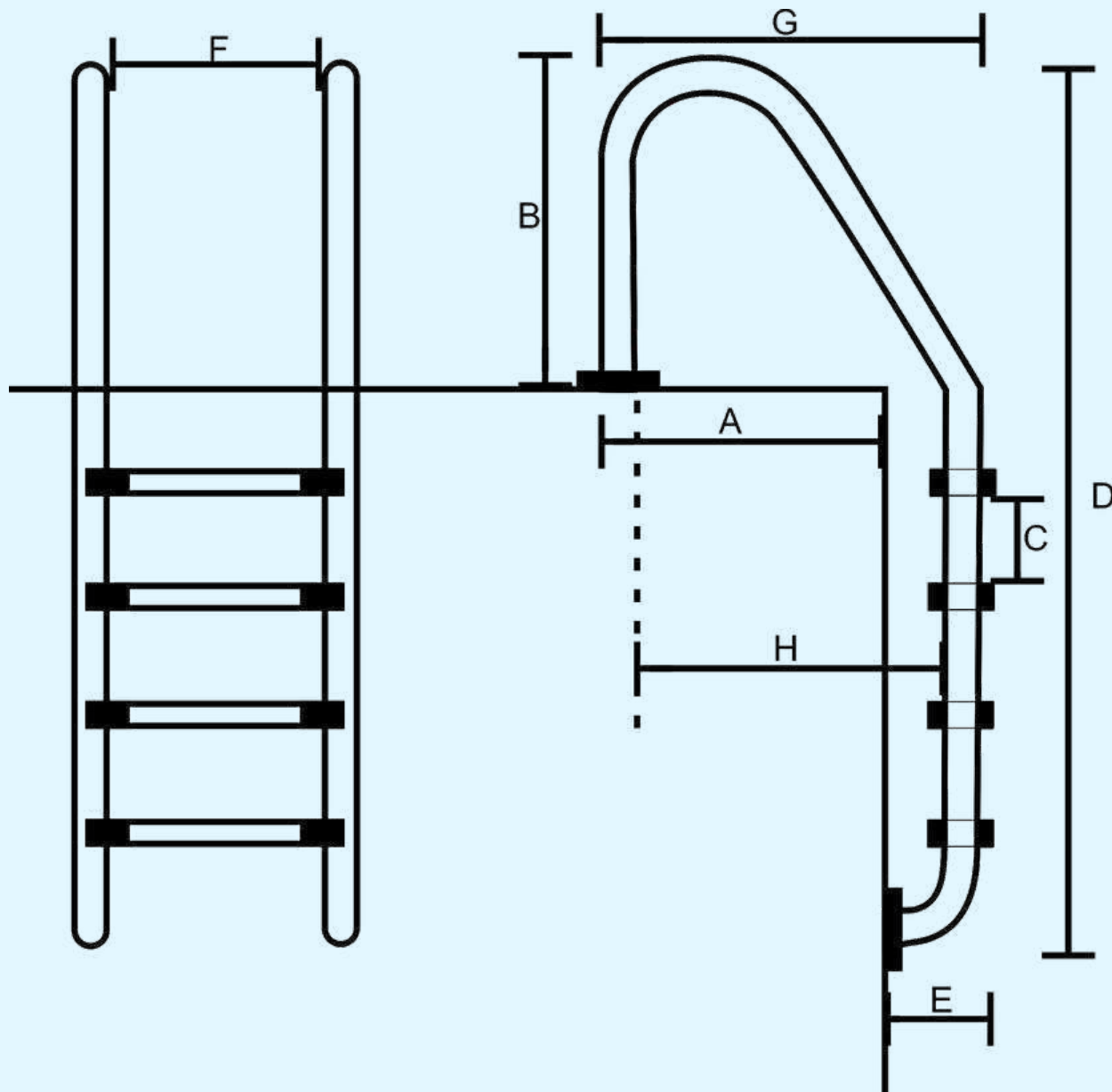

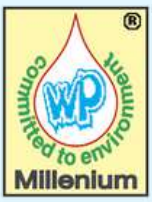

MU SERIES LADDER

MU Series Ladder Water Pool Ladders are made with high quality grade SS 304, stainless steel 38/42mm tube for reliability and durability complete with anchoring fixtures.



CO DE	Tra des	A	B	C	D	E	F	G	H
MU - 215	2	180	710	250	1450	230	460	565	340
MU - 315	3	180	710	250	1700	230	460	565	340
MU - 415	4	180	710	250	1950	230	460	565	340
MU - 515	4	180	710	250	2200	230	460	565	340

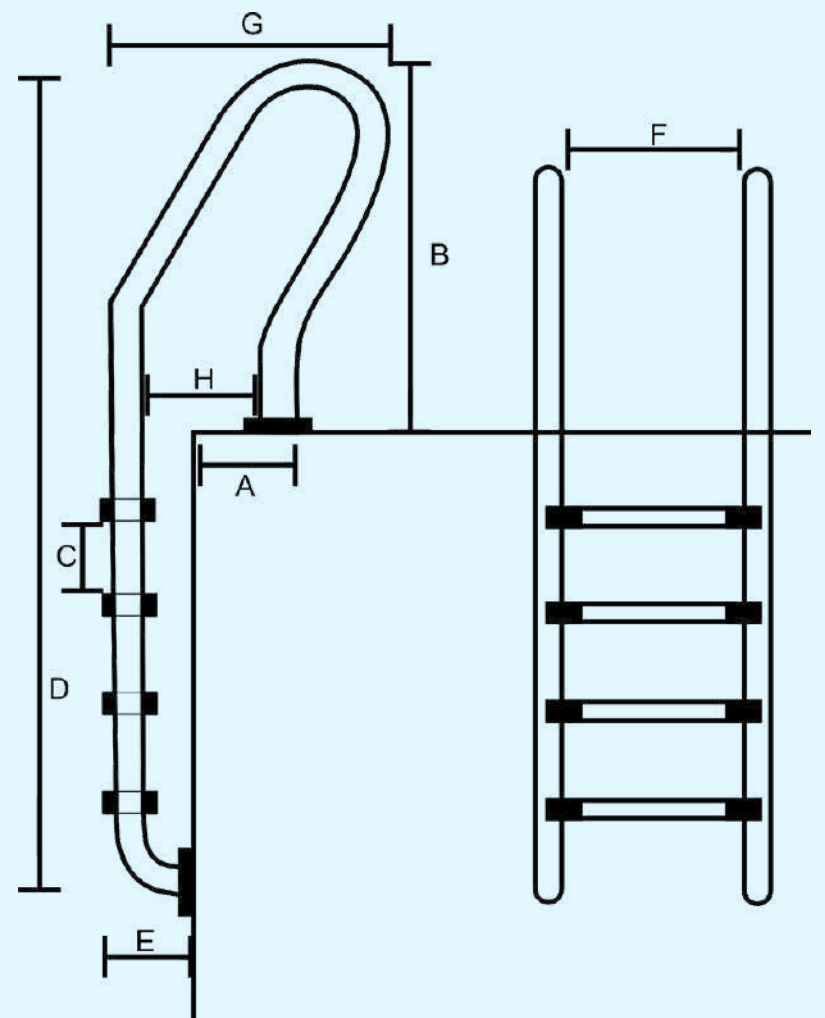
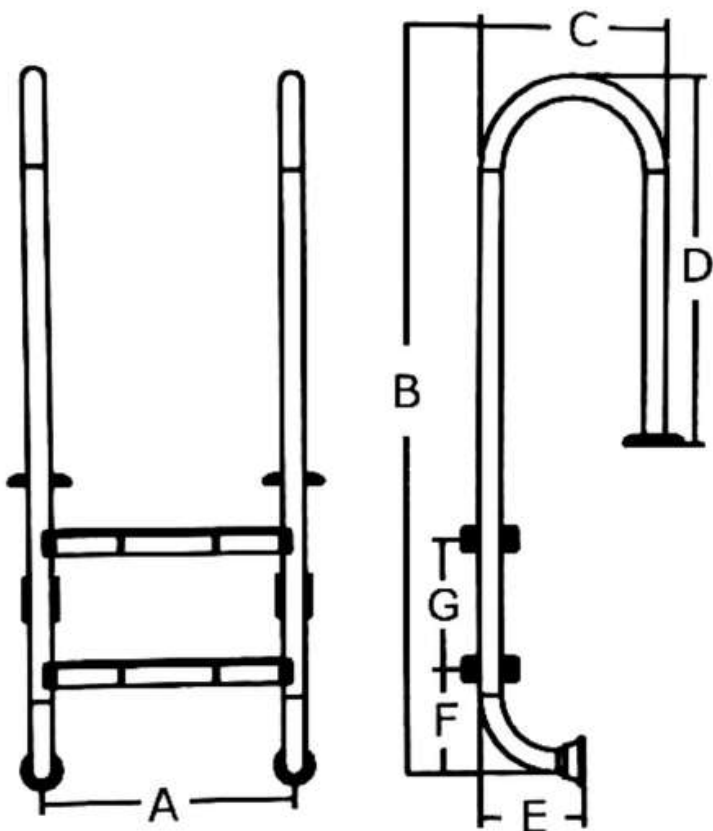



Water Point
Millenium

ABS POOL LADDER STEPS



POOL SS LADDER STEPS





SOLAR SHOWER

STAINLESS STEEL SHOWER



MST2020L

2-section Solar Shower

MST20F20L

2-section Solar Shower with foot wash tap

Item No	Capacity	Height (mm)	Tube Dia (mm)	Function	Material		G.W.	QTY(SETS)	
					Tube	Base		KGS	20'GP
MST20	20L	2200	Φ160	Shower	PVC	ALU	7.5	500	1000
MST20F	20L	2200	Φ160	Shower Footwash	PVC	ALU	7.5	500	1000



STAINLESS STEEL SHOWER



MSC38F 38L Painting Solar Shower with foot wash tap

MSC40F 40L Painting Solar Shower with foot wash tap

MSC38F/2 38L Painting Solar Shower with foot wash tap in 2-sections

MSC40F/2 40L Painting Solar Shower with foot wash tap in 2 sections

Item No	Capacity	Height (mm)	Tube Dia (mm)	Function	Material		G.W. KGS	QTY(SETS)	
					Tube	Base		20'GP	40'HQ
MSC38F	38L	2200	Φ160	Shower Footwas h	PVC	ALU	11	250	560
MSC40F	40L	2200	Φ160	Shower Footwas h	PVC	ALU	11.5	240	550
MSC38F/2	38L	2200	Φ160	Shower Footwas h	PVC	ALU	11.5	250	560
MSC40F	40L	2200	Φ160	Shower Footwas h	PVC	ALU	11.5	240	550



Water Point
Millenium

SOLAR HEATER GROUND POOL



STRAIGHT SOLAR SHOWER



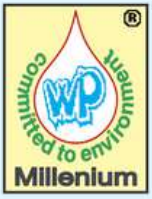

Water Point
Millennium

JACUZZI



WP-127



WP-128



WP-125



WP-124



WP-126



Water Point
Millennium

POOL-HEATING-SYSTEM

SPA HEATER



Spa Heater

The Water Point Spa Heaters are intended for use small pools, jacuzzi and spa system. It will maintained the water at any relaxing and an enjoyable temperature.

FEATURES:

- Digital Control Panel.
- Powder Coated/ Stainless Steel Cabinet.
- Ip36 Water Proofing.
- User Friendly.
- Easy Installation
- Easy Servicing.
- Suitable for small pools jacuzzi and spas.
- Shut down automatically.
- Can be set at desired temperature.
- Available in 9kw, 12kw, 15kw, 18kw, 20kw, 24kw, 30kw 35kw, 40kw, 45kw, 50kw, 55kw, 60kw.

DOMESTIC HEAT PUMP



Domestic Heat Pump

Patented high-performance titanium exchanger has more stable performance and greatly resist erosion of chlorine ion water, solid and durable.

Exterior is anti-UV plastic ABS corrosion resistant casing material with injection model or normal plastic model.

By using high-heat exchanger technology, 65-80% of running cost can be saved compared with other heating machines. It consumes 1kw to produce about 5.5kw heating capacity, possessing high COP.

Heating and cooling with reversible defrosting.

Remote and intelligent controller design with Celsius of fahrenheit temperature display for options.

LCD or colorful LED controller for options Super power failure memory.

Flow switch built-in to avoid the low level water or devoid of water.

Advanced technology to mute noise from compressors and fans.

Designed by : Web Flow India



Water Point
Millennium

COMMERCIAL HEAT PUMP



Commercial Heat Pump

Patented high-performance titanium exchanger has more stable performance and greatly resist erosion of chlorine ion water, solid and durable.

Exterior is anti-UV plastic ABS corrosion resistant casing material with injection model or normal plastic model.

By using high-heat exchanger technology, 65-80% of running cost can be saved compared with other heating machines. It consumes 1kw to produce about 5.5kw heating capacity, possessing high COP.

Heating and cooling with reversible defrosting.

Remote and intelligent controller design with Celsius of fahrenheit temperature display for options.

LCD or colorful LED controller for options

Super power failure memory

Flow switch built-in to avoid the low level water or devoid of water.

Advanced technology to mute noise from compressors and fans.

OZONE GENERATOR



Ozone Generator



Water Point
Millennium

ELECTRO HEATER



FEATURES:

- Fully equipped
- Easy Installation
- Robust, durable construction
- Analogue control with 1C Differential
- Incoloy 825 or Titanium heating elements
- 316 Stainless Steel or Titanium flow tube
- Ultra-reliable flow switch allows safe operation as low as 1,000 ltr/h
- May be floor or wall mounted using swivel foot
- Control thermostat and safety thermal cut out (manual reset)
- 3 years conditional warranty

CONSTRUCTION

The ELECRO EVOLUTION pool heater is manufactured from top quality components and materials at the Elecra works in Hertfordshire, England.

Construction consists of a flow tube which is fitted with Inlet and Outlet mouldings manufactured from specially formulated polymer alloy material. Universal ABS unions are provided to allow solvent weld connection to the inlet and outlet pipe work. The outlet moulding accommodates a reversible flow switch with a gold tipped reed, and Titanium pin.

The heater is supported on two swivel feet; these can swivel to permit either wall or floor mounting. The heater control components are positioned on the front face of the casing. The water inlet and outlet fittings can facilitate connection to either metric or imperial standard pipe. The inlet moulding has been designed to ensure full immersion of the elements, greatly reducing the risks of air locking.

OPERATION

The desired pool temperature can be easily set on the ELECRO EVOLUTION heater using the panel-mounted thermostat dial. The single or three-phase power is supplied through a top quality Schneider contactor. Safety and equipment protection is provided by the highly reliable flow switch. Over-temperature protection is provided by the thermal cut out (manual reset).

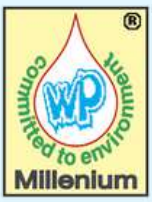

Water Point
Millennium

POOL SIDE FURNITURE





Water Point
Millenium

LIFE SAVING EQUIPMENTS



Intex Rectangular Pool



Sports Kick Board/Pad



Economat/Floating Bad



Fashion Mat(Assorted Colors)



Swimming Ring Tyre Shape



Swimming Ring



Nutty Donut Tube



Swim Ring Tube



Rainbow Sprinkle Donut Tube



Life Buoy



Intex Round Pool



Life Guard Jacket

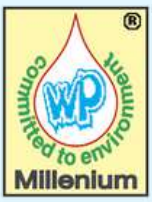

Water Point Millennium



Life Jacket



Life Jacket



Shepherd Hook



Pool Buoy



Arm Band



Foot Bath



Swimming Cap



Artificial Respirator



Folding Stretcher



First Aid Box



Swimming Goggles



Arm Band

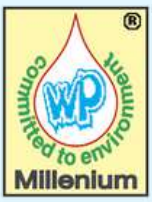

SAUNA & STEAM

SAUNA HEATER



FEATURES AND ADVANTAGES:-

- Stainless steel outer casing of the heater.
- Operating Switches are placed on the upper part on the side of the heater.
- Sauna heater is suitable for dry or wet saunas.
- Heavy duty electrical elements and long durability.
- Easy to install
- Fast warm - up due to vented body design.

BENEFITS:-

- Relieves congestion.
- Relaxes from overworked muscles.
- Deeply clean and moisturizes the skin.
- Detox your body.
- It makes you feel mentally/physically relaxed

SAUNA GENERATOR



STEAM GENERATOR STANDARD FEATURES & ADVANTAGE:-

- Stainless steel reservoir.
- Heavy duty heating element.
- Electronic water-level control system.
- Safety valve for extra precaution
- Built-in low voltage protector.
- Available in 4Kw, 6Kw, 7.5Kw, 8Kw, 9Kw, 10Kw, 12Kw, 13.5Kw, 15Kw, 16.5Kw, 18Kw., 19.5Kw, 21Kw & 21.5Kw, 22Kw.

SAUNA ROOM & ACCESSORIES



SAUNA ROOM & ACCESSORIES

A sauna is a small size of room can be heated at very high temperature, with well control humidity. The water point benefit and therapeutic value saunas provide have been known for countries. water point offers arange of saunas to help relax and improve overall health as well as promote well being. Saunas are also used for recreational purpose. Standard residential sauna sizes are- 5'x7' & 6'x7'. Top bench should be 7' long.

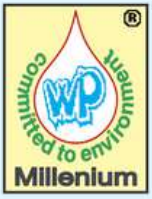

Water Point *Millennium*



WP-3025



WP-1815



WP-2020



WP-2018



WP-2015

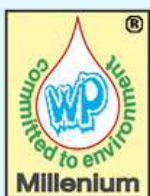

Water Point
Millennium

SPA BATH FITTINGS

STANDARD JET (SMOOTH FACE)



MODEL NO: MA-107

Standard Jet (Smooth Face)

Color : White

Material: ABS

JACUZZI JET / SPA JET



MODEL NO: MA-108

JacuzziJet / Spa Jet

Color : White

Material: ABS

Size: 50mm x 50mm

JACUZZI JET / SPA JET (SS FACE)



MODEL NO:MA-109

Jacuzzi Jet / Spa Jet (SS Face)

Color : White

Material: ABS

Size: 50mm x 50mm

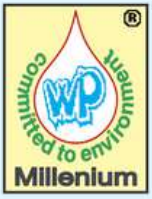

Water Point
Millennium

PNEUMATIC SWITCH



MODEL NO: MA-110

Pneumatic Switch

Color : Black / White

Material: ABS

HEAVY DUTY VORTEX AIR BLOWER



MODEL NO:MA-111

Heavy Duty Vortex Air Blower

1HP/XB750, 1.5HP/XB1100

2HP/XB1500,3HP/XB2200

Material: Aluminium

MULTI HOLE AIR BUBBLE JET



MODEL NO: MA-112

Multi Hole Air Bubble Jet

Color : White

Material: ABS

Size : 20mm



Water Point
Millennium

PNEUMATIC SWITCH



MODEL NO: MA-110

Pneumatic Switch

Color : Black / White

Material: ABS

NINE HOLE JET



MODEL NO:MA-113

Nine Hole Jet

Color : White

Material: ABS

Size : 27mm

SS AIR CONTROLLER



MODEL NO:MA-114

SS Air Controller

Color : White

Material: ABS

Size : -

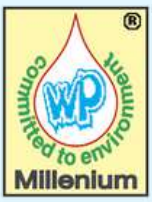

Water Point
Millennium

PUSH / AIR BUTTON



MODEL NO: MA-116

Push / Air Button

Color : White / Chrome

Material: ABS

Size : 35mm

GUTTER DRAIN



MODEL NO:MA-117

Gutter Drain

Color : White

Material: ABS

Size : 1.5"/2"

STANDARD AIR CONTROLLER



MODEL NO:MA-118

Standard Air Controller

Color : White

Material: ABS

Size : 1.5"

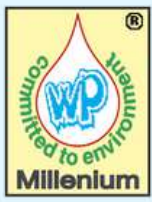

COUNTER CURRENT SYSTEM

COUNTER FLOW SYSTEM PUMP



Single-stage centrifugal pumps with complete drainage device.

Inbuilt counterflow system.

This jet streams is ready for easy installation. It is possible to regulate the jet strength adjustable. The nozzle, suction and pneumatic switch are positioned in the front cover panel of the equipment complete counter-flow system includes. Counterflow nozzle 40mm(regulation water-air)

Front cover panel-attractive design

wall lead-through

Pump

Electroneumatic switch with safety element

PVC fitting

MOTOR:

- Asynchronous two poles.
- IP 55 protection.
- Class F insulation.
- Continuous operation.

MATERIALS:

- Suction and discharge mounting in polypropylene.
- Motor shaft in stainless steel AISI-304
- impeller in PPO.
- Mechanical Seal in graphite and steatite.
- Motor housing aluminum L-2521



Water Point
Millennium

SWIM JET 3000



- Jet Swim house made of stainless steel, front and handle made of polished acid-proof stainless steel AISI 304. For mounting in concrete, wood or building block walls.
- Lpump power: 3KW
- Control box including contractor and overhead protection
- Air mixture control
- Air mixture hose
- Hose connectors
- Hose clamps
- Hose for suction and pressure
- Valves

COUNTER FLOW SYSTEM PUMP





GRATINGS

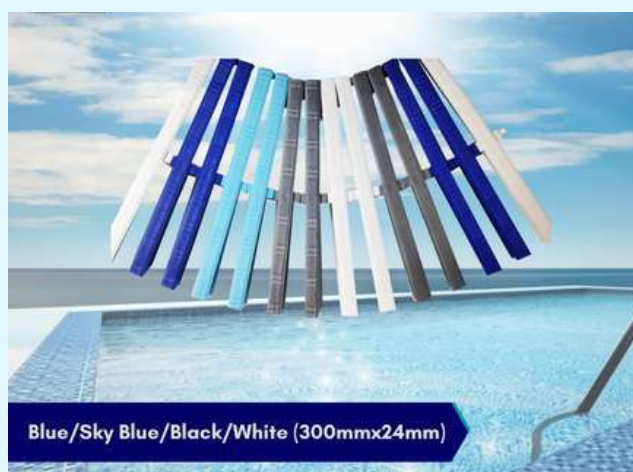
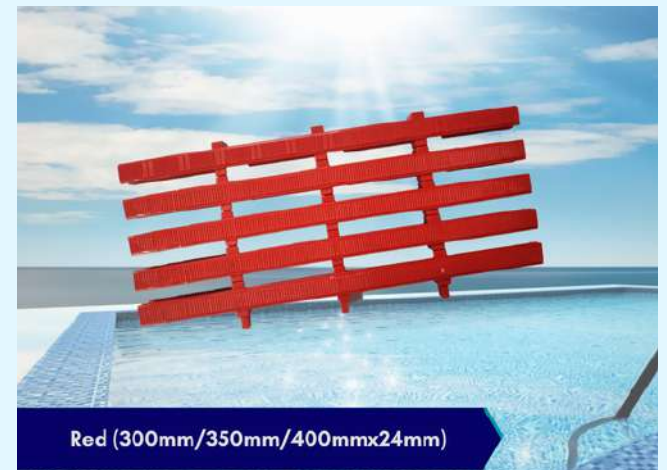
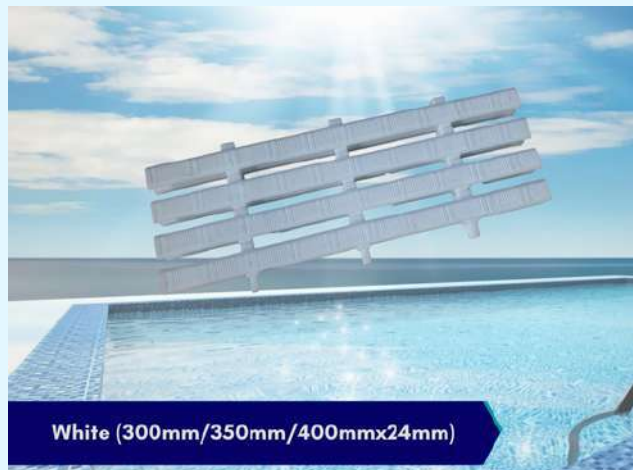



Water Point
Millennium

SWIMMING POOL FITTINGS

EYE BALL DIFFUSER NOZZLE



MODEL NO:MA-001

Eye Ball Diffuser Nozzle

Color: White
Flow Rate: 9M³/hr

Floor inlets Made in White ABS, These are UV resisted and are appreciated for longer service life. Connection 50mm / 63mm

SINGLE HOLE JE



MODEL NO: MA-003

Single Hole Je

Color: White
Flow Rate: 12M³/hr

Adjustable Floor inlets Made in White ABS, with multiple flow UV protected appreciated for long life. Connection 50mm / 63mm



Water Point
Millennium

WALL RETURN/ FLOOR INTEL GRILL TYPE

MODEL NO:MA-004



Wall Return/ Floor Intel Grill Type

Color: White

Flow Rate: 4.5M³/hr

Wall Return/ Floor Intel Grill Type inlets Made in White ABS, with multiple flow UV protected appreciated for long life. Connection 50mm / 63mm suitable for 10 & 6 Kg pressure

WALL RETURN/FLOOR INLET FLOWER TYPE

MODEL NO:MA-004



Wall Return/Floor Inlet Flower Type

Color: White

Flow Rate: 4.5M³/hr

Wall Return/Floor Inlet Flower Type inlets Made in White ABS, with multiple flow UV protected appreciated for long life. Connection 50mm / 63mm suitable for 10 & 6 Kg pressure



Water Point
Millennium

VACCUM POINT / SUCTION INLET



Vaccum Point / Suction Inlet

MODEL NO:MA-007

Vaccum point / suction Inlet

Color: White

Flow Rate: 4.5M³/hr

Suction inlets Made in White ABS, These are UV resisted and are appreciated for longer service life. Connection 63mm

CIRCULAR MAIN DRAIN



Circular Main Drain

MODEL NO: MA-008

Circular Main Drain

Color: White

Flow Rate: 9M³/hr

Size: 63mm Threaded Material ABS

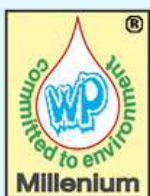

Water Point
Millennium

SQUARE MAIN DRAIN



MODEL NO:MA-010

Square Main Drain

Color: White

Size: 50mm/63mm thread

Wide Mouth Skimmer for Concrete
Pool Material - ABS

MINI SKIMMER



MODEL NO:MA-011

Mini Skimmer

Color: White

Flow Rate: 9M³/hr

Mini Skimmer for Concrete/Vinyl Pool
Material ABS Connection 1-1/2"
Threaded

STANDARD SKIMMER



MODEL NO: MA-013

Standard Skimmer

Color: Chrome Finish

Flow Rate: 850 L/min

Size: 300mm X 300mm 450mm X
450mm Material Stainless Steel



Water Point
Millennium

ABS SQUARE MAIN DRAIN



MODEL NO:HA-014

Abs Square Main Drain

Color: White

Flow Rate: 63mm

Circular ABS Main Drain for
Concrete Pool w/170mm in
Diameter & 2" int.tr

WIDE MOUTH



MODEL NO:MA-012

Wide Mouth

Color: White

Flow Rate: 850L / Min

Squire Main Drian 300mm X
300mm Material-ABS

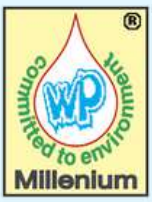

Water Point
Millennium

TILES

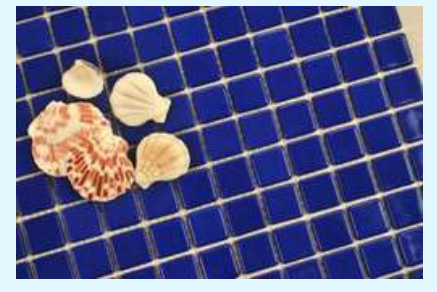
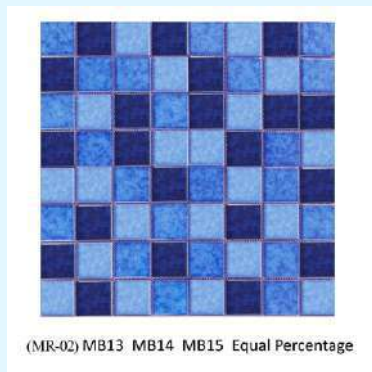
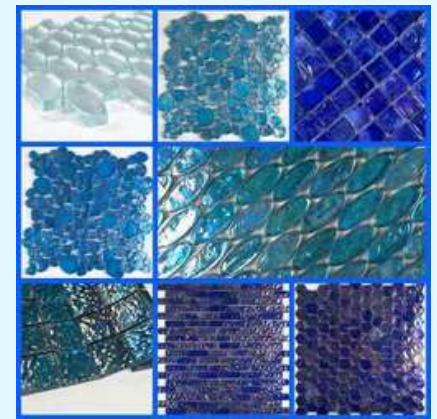
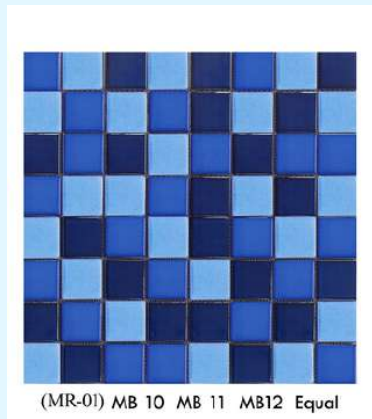
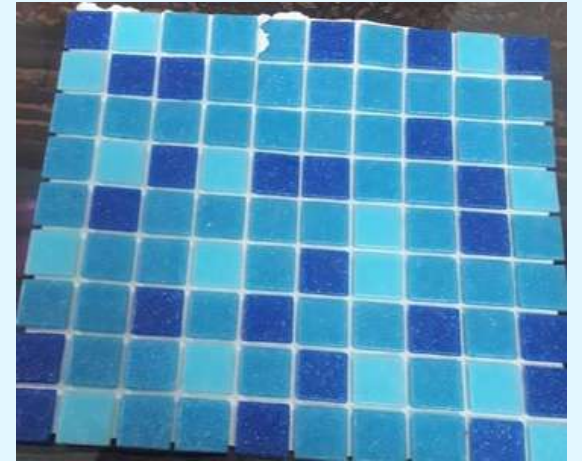
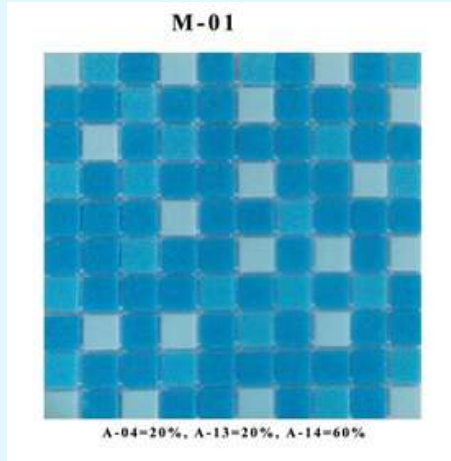
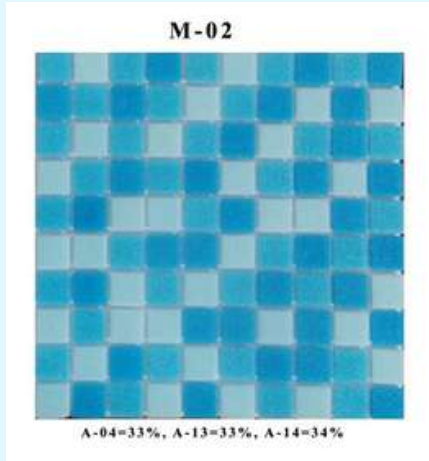

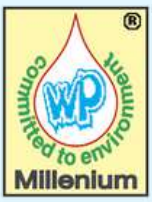

Water Point

Millenium

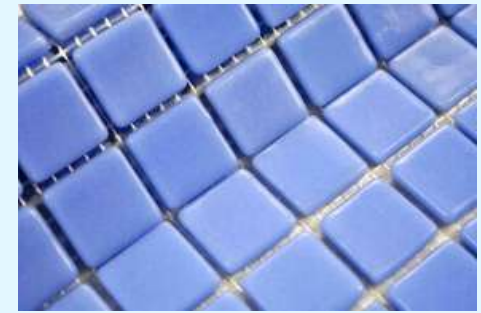
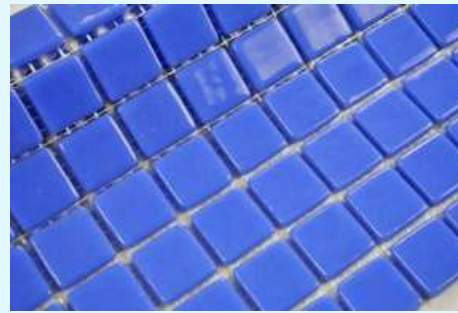
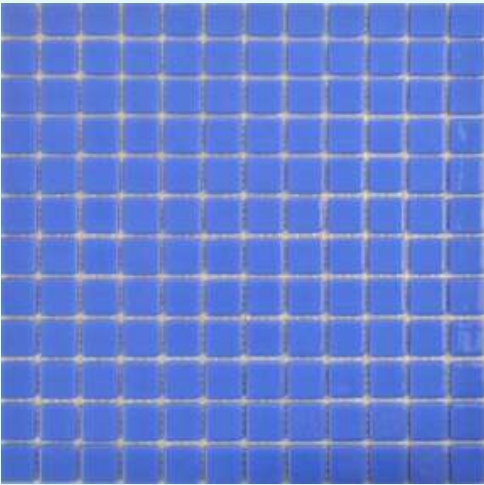
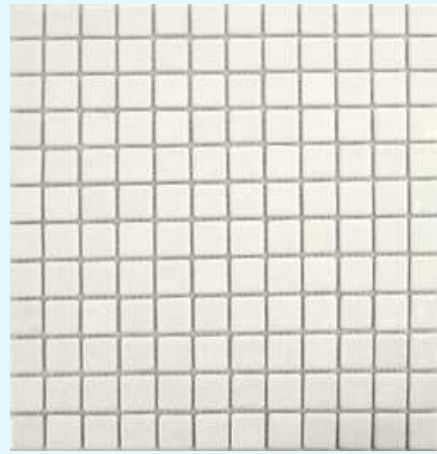
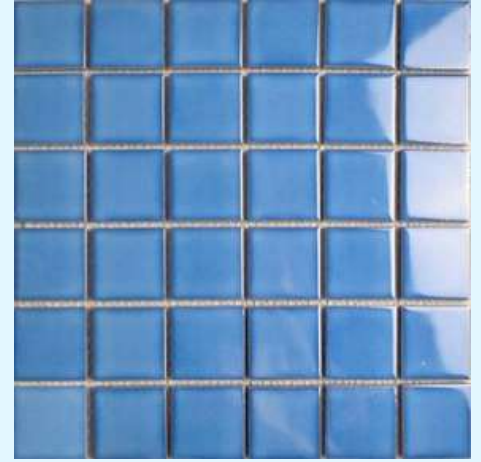
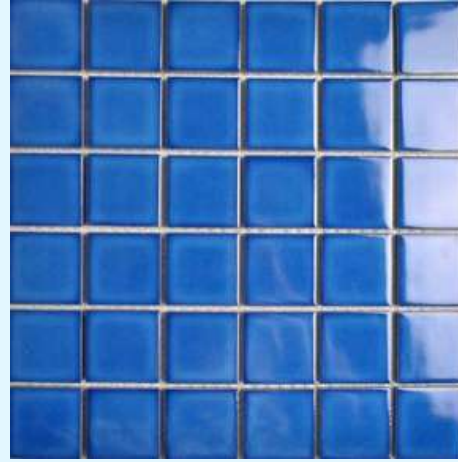

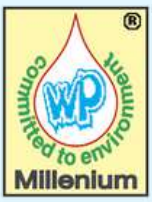

WATER FEATURES

CASCADE FALL



MODEL NO:HA-299

Cascade Fall

Material: SS-316/304
Opening Width/Height (mm)
W: 300/450/600/900

CASCADE FALL



Model No: HA-298

Cascade Fall

Material: SS-316/304
Opening Width (mm)
W: 300/450/600/900

CASCADE FALL



MODEL NO:HA-300

Cascade Fall

Material: SS-316/304
Opening Width (mm)
W: 300/450/600/900

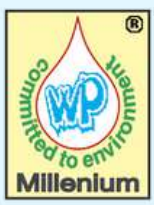

Water Point
Millennium

RECTANGULAR WATER CURTAIN



MODEL NO:HA-305

Rectangular Water Curtain

(Rain Effect)

Material: SS-316/304

Opening Width/Height (mm)

W: 300/500/700/1000

H: 700/700/700/700

WATER FALL



MODEL NO: HA-302

Water Fall

Material: SS-316/304

Opening Width/Height (mm)

W: 150/300/500/700/1000

H: 700/700/700/700/700

WATER FALL CURTAIN



MODEL NO:HA-304

Rectangular Water Curtain

Material: SS-316/304

Opening Width/Height (mm)

W: 300/500/700/1000

H: 700/700/700/700

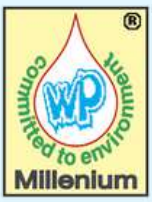

Water Point
Millenium

WATER SLIDES



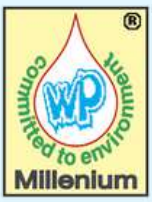

Water Point
Millenium

WATER TREATMENT



HCL



Extra Power Pool Cleaner



Copper Sulphate



TCCA 90 Granular



TCCA 90 Tablet



Sodium Hypochlorite Solution



Uv Disinfector



Floating Dispenser



Halbert Electronic Dosing Pump



Thermometer



Hardness Kit



Uvf 360w - 2160w



Inline Chemical Dispenser



Chlorine Feeder

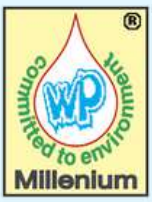

Water Point
Millennium

WATER SOFTENER



Resin Based Water Softener



Domestic Water Softener



Water Softener for whole house



Automatic Water Softener



Commercial Water Softener



Water Treatment Plant



Water Softener and D.M Plant



Water Softener



Water Point
Millennium

RO PURIFIER

RO PURIFIER



FEATURES:

- The fiberglass winding design enables the filter to be durable, deforming-proof and corrosion resistant
- A unique and advanced design ensures fast draining and stabilizes water flow.
- The 6-position multi-port valve with a user friendly handle easily provides you a maximum flow at low pressure drop.
- The Sand filter comes with a precise pressure gauge.
- It is easy to install and to maintain.
- The Outlet turbidity is less than 2FTU.
- Working pressure is 2.5 Kg cm²/36 psi.
- UV resistance surface allows the filter to work under direct sunlight.
- Maximum operating temperature is 50°C.

RO PURIFIER



FEATURES:

- The fiberglass winding design enables the filter to be durable, deforming-proof and corrosion resistant
- A unique and advanced design ensures fast draining and stabilizes water flow.
- The 6-position multi-port valve with a user friendly handle easily provides you a maximum flow at low pressure drop.
- The Sand filter comes with a precise pressure gauge.
- It is easy to install and to maintain.
- The Outlet turbidity is less than 2FTU.
- Working pressure is 2.5 Kg cm²/36 psi.
- UV resistance surface allows the filter to work under direct sunlight.
- Maximum operating temperature is 50°C.

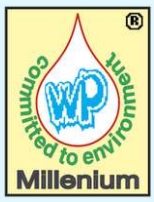

Water Point
Millenium

RO PURIFIER



FEATURES:

- The fiberglass winding design enables the filter to be durable, deforming-proof and corrosion resistant
- A unique and advanced design ensures fast draining and stabilizes water flow.
- The 6-position multi-port valve with a user friendly handle easily provides you a maximum flow at low pressure drop.
- The Sand filter comes with a precise pressure gauge.
- It is easy to install and to maintain.
- The Outlet turbidity is less than 2FTU.
- Working pressure is 2.5 Kg cm²/36 psi.
- UV resistance surface allows the filter to work under direct sunlight.
- Maximum operating temperature is 50°C.

RO PURIFIER



FEATURES:

- The fiberglass winding design enables the filter to be durable, deforming-proof and corrosion resistant
- A unique and advanced design ensures fast draining and stabilizes water flow.
- The 6-position multi-port valve with a user friendly handle easily provides you a maximum flow at low pressure drop.
- The Sand filter comes with a precise pressure gauge.
- It is easy to install and to maintain.
- The Outlet turbidity is less than 2FTU.
- Working pressure is 2.5 Kg cm²/36 psi.
- UV resistance surface allows the filter to work under direct sunlight.
- Maximum operating temperature is 50°C.

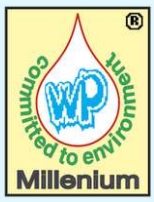

Water Point
Millennium

RO PURIFIER



FEATURES:

- The fiberglass winding design enables the filter to be durable, deforming-proof and corrosion resistant
- A unique and advanced design ensures fast draining and stabilizes water flow.
- The 6-position multi-port valve with a user friendly handle easily provides you a maximum flow at low pressure drop.
- The Sand filter comes with a precise pressure gauge.
- It is easy to install and to maintain.
- The Outlet turbidity is less than 2FTU.
- Working pressure is 2.5 Kg cm²/36 psi.
- UV resistance surface allows the filter to work under direct sunlight.
- Maximum operating temperature is 50°C.

RO PURIFIER



FEATURES:

- The fiberglass winding design enables the filter to be durable, deforming-proof and corrosion resistant
- A unique and advanced design ensures fast draining and stabilizes water flow.
- The 6-position multi-port valve with a user friendly handle easily provides you a maximum flow at low pressure drop.
- The Sand filter comes with a precise pressure gauge.
- It is easy to install and to maintain.
- The Outlet turbidity is less than 2FTU.
- Working pressure is 2.5 Kg cm²/36 psi.
- UV resistance surface allows the filter to work under direct sunlight.
- Maximum operating temperature is 50°C.

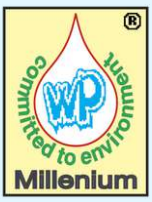

Water Point
Millenium

RO PURIFIER

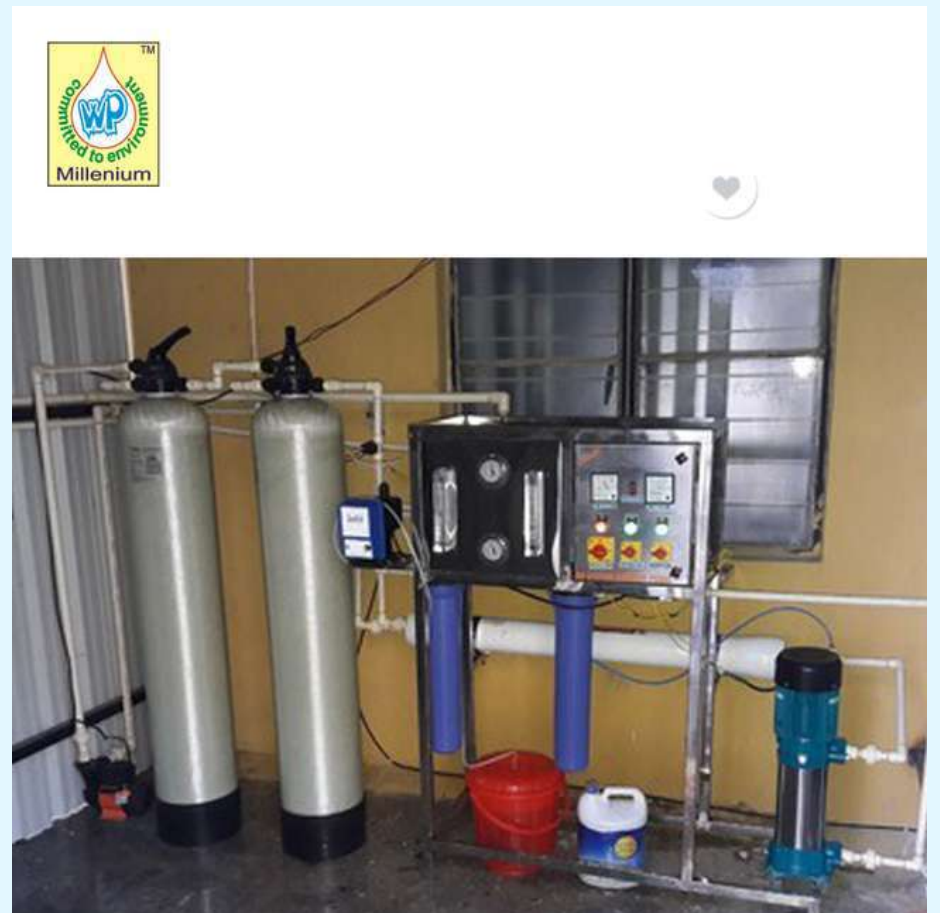
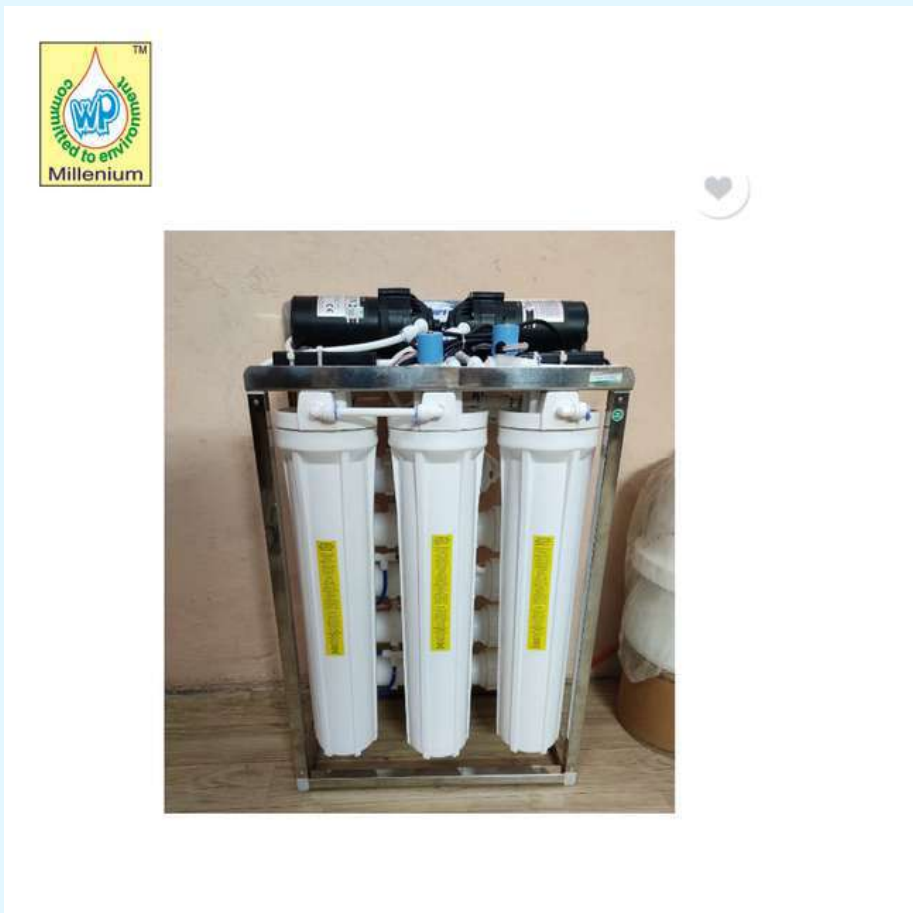



Water Point

Millennium



Office No:-6, First Floor, Ram Raghu Plaza, Khandari Road, Agra, Uttar Pradesh-282002 (India)



**+91-9837036023
+0562-4062700**



waterpoint2002@gmail.com



www.waterpointindia.com